

HSF

NOTES:

Rated Current:1.5AMP.(20°C,2*2P-2*15P)
 1.0AMP.(20°C,2*16P-2*50P)
 Contact Resistance:20mΩ Max.
 Withstand Voltage:500V AC/DC
 Insulation Resistance:1000MΩ Min.
 Operation Temperature:-40°C to +125°C(Gold Plating)

Contact Material:Copper Alloy
 Contact Plating:Au Over 30u" Min Ni
 Insulator Material:PA9T+G.F UL94V-0 BK

Ordering Information

2321-2 XX S XX C U N T 1

Plastic Row
 No. of Pins Per Row:02-50
 Welding Type S=S/T
 Contact Plating G0=Gold Flash
 G3=10u"Au, BG3=8u"PdNi+2u"Au
 G4=15u"Au, BG4=13u"PdNi+2u"Au
 G5=30u"Au, BG5=28u"PdNi+2u"Au
 Logo N=W/O Logo
 Contact Type U=U Type
 Insulator Material C=PA9T
 Packing: T=Tube
 Series No.

Recommended P.C.B Layout(Top Side)
 (PCB BOARD TOLERANCE±0.05)
 (PCB Thickness:T=1.60m)

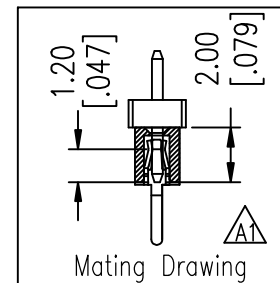
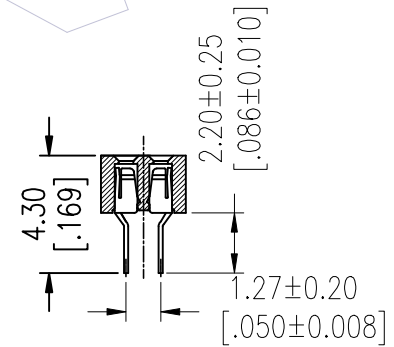
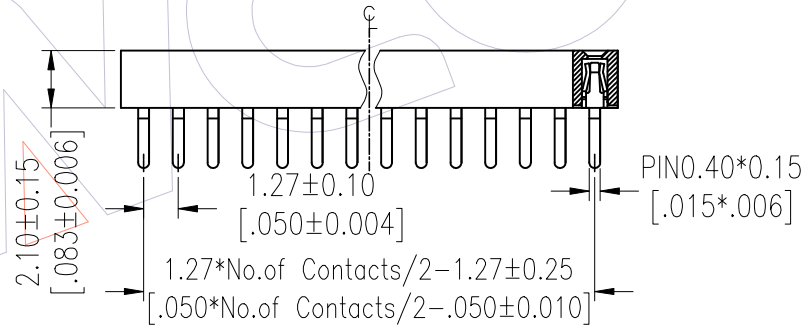
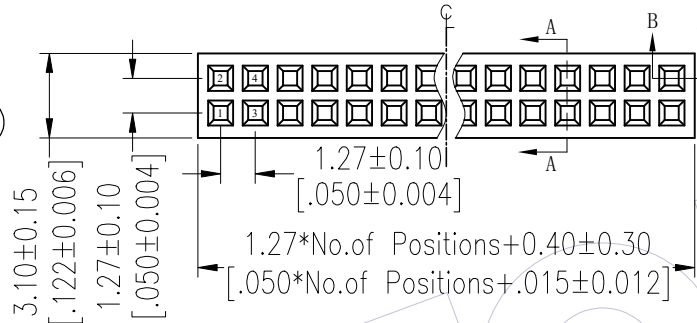
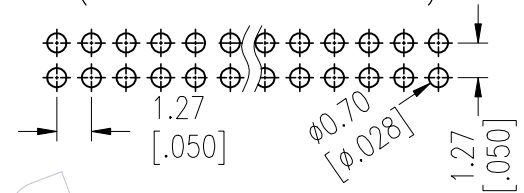

Item	Pitch	Mating	DIM.B
Standard	1.27	1310/1315/1320	2.00
Alternate			

REV	DATE	MODIFICATION DESCRIPTION	CHANGE	OPERATION	DRAW	DATE	SCALE	FIT	PART NO.
A1	2025/12/15	Standardization Drawing	BAO	x.X ±0.40	BAO	2025/12/15	UNIT	mm	2321-2XXSXXCUNT1
AO	2012/07/05	NEW	-----	x.XX ±0.25	CHECK	2025/12/15	SIZE	A4	TITLE: 1.27mm DUAL FEMALE HEADER 180 H=2.1
				x.XXX ±0.15	TANG		SHEET	1/2	Customer NO.
				Angle ± 3'	APPROVE	2025/12/15	PROJ.		
				DIM TOL	Steven Zhao				

WCON
 Http: www.wcon.com

WCON-Dongguan
 Tel: +86 769 85358920
 Fax: +86 769 85358915
 E-mail: sales@wcon.com

WCON-Kunshan
 Tel: +86 512 57468408
 Fax: +86 512 57468468
 E-mail: salesks@wcon.com

HSF

Packaging Quantity Refers To The Following Table

Packing: 

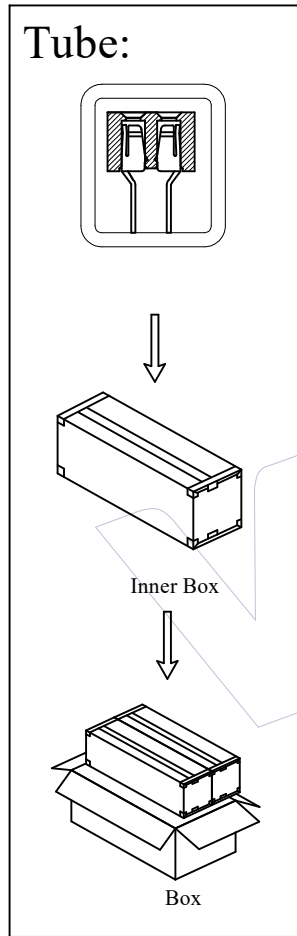

PINS /Row	Q' ty/Tube	Q' ty/Inner Box	Q' ty/Box
2	800/Tray	/	38,400
3	137	68,500	137,000
4	105	52,500	105,000
5	85	42,500	85,000
6	72	36,000	72,000
7	62	31,000	62,000
8	54	27,000	54,000
9	49	24,500	49,000
10	44	22,000	44,000
11	40	20,000	40,000
12	37	18,500	37,000
13	34	17,000	34,000
14	31	15,500	31,000
15	29	14,500	29,000
16	27	13,500	27,000
17	26	13,000	26,000
18	24	12,000	24,000
19	23	11,500	23,000
20	22	11,000	22,000
21	21	10,500	21,000
22	20	10,000	20,000
23	19	9,500	19,000
24	18	9,000	18,000
25	18	9,000	18,000
26	17	8,500	17,000

PINS /Row	Q' ty/Tube	Q' ty/Inner Box	Q' ty/Box
27	16	8,000	16,000
28	16	8,000	16,000
29	15	7,500	15,000
30	15	7,500	15,000
31	14	7,000	14,000
32	14	7,000	14,000
33	13	6,500	13,000
34	13	6,500	13,000
35	13	6,500	13,000
36	12	6,000	12,000
37	12	6,000	12,000
38	12	6,000	12,000
39	11	5,500	11,000
40	11	5,500	11,000
41	10	5,000	10,000
42	10	5,000	10,000
43	10	5,000	10,000
44	10	5,000	10,000
45	10	5,000	10,000
46	9	4,500	9,000
47	9	4,500	9,000
48	9	4,500	9,000
49	9	4,500	9,000
50	9	4,500	9,000

REV	DATE	MODIFICATION DESCRIPTION	CHANGE	OPERATION	DRAW	DATE	SCALE	FIT	PART NO.
A1	2025/12/15	Standardization Drawing	BAO	x.X ±0.40	BAO	2025/12/15	UNIT	mm	2321-2XXSXXCUNT1
AO	2012/07/05	NEW	-----	x.XX ±0.25	CHECK	2025/12/15	SIZE	A4	TITLE: 1.27mm DUAL FEMALE HEADER 180 H=2.1
				x.XXX ±0.15	TANG		SHEET	2/2	Customer NO.
				Angle ± 3'	APPROVE	2025/12/15	PROJ.		
				DIM TOL	Steven Zhao				

WCON
Http: www.wcon.com

WCON-Dongguan Tel: +86 769 85358920
WCON-Kunshan Tel: +86 512 57468408
Fax: +86 769 85358915
E-mail: sales@wcon.com Fax: +86 512 57468468
E-mail: salesks@wcon.com