

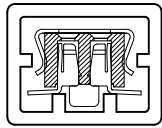

# HSF Packing:

## Tube:



W/T CAP

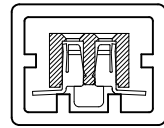

W/O CAP

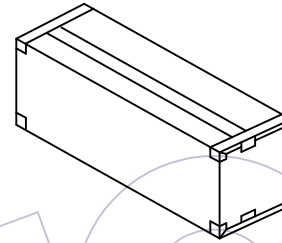
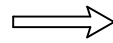

Inner Box

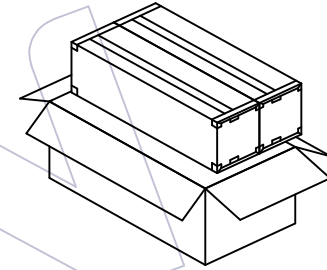
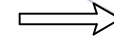

Box

## Reel:

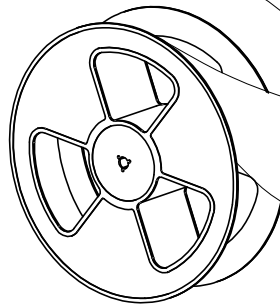

客户安装时拉出方向  
Customer pull out direction

Round

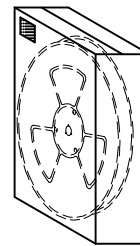
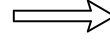
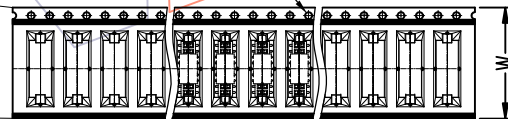

Inner Box

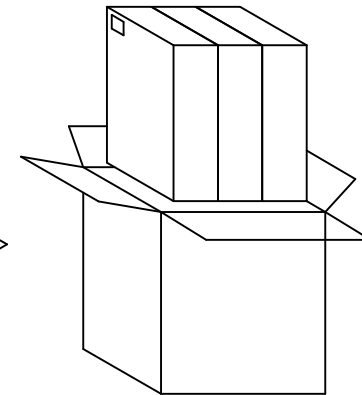
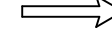

Box (Put in 3 Inner Box)

A5	2025/12/15	Standardization Drawing	BAO	OPERATION	DRAW	DATE	SCALE	FIT	PART NO.
A4	2023/02/03	Modify Flatness	XSR	x.x ±0.40	BAO	2025/12/15	UNIT	mm	2321-2XXMXXCUNX3
A3	2016/06/17	Modify CAP 3.00 → 3.40	-----	x.xx ±0.25	CHECK	DATE	SIZE	A4	TITLE:
A0	2012/07/05	NEW	-----	x.xxx ±0.15	TANG	2025/12/15	SHEET	2/3	1.27mm DUAL FEMALE HEADER SMT WITH OUTSIDE POST
REV	DATE	MODIFICATION DESCRIPTION	CHANGE	Angle ± 3'	APPROVE	DATE	PROJ.	⌀	Customer NO.
				DIM TOL	Steven Zhao	2025/12/15			

**WCON**

Http: www.wcon.com

WCON-Dongguan Tel: +86 769 85358920 Fax: +86 769 85358915 E-mail: sales@wcon.com	WCON-Kunshan Tel: +86 512 57468408 Fax: +86 512 57468468 E-mail: salesks@wcon.com
---	--

HSF

## Packaging Quantity Refers To The Following Table

PINS /Row	Q' ty/Tube	Q' ty/Inner Box	Q' ty/Box
2	800/Tray	/	38,400
3	600/Tray	/	28,800
4	70	35,000	70,000
5	61	30,500	61,000
6	54	27,000	54,000
7	48	24,000	48,000
8	43	21,500	43,000
9	39	19,500	39,000
10	36	18,000	36,000
11	33	16,500	33,000
12	31	15,500	31,000
13	29	14,500	29,000
14	28	14,000	28,000
15	26	13,000	26,000
16	24	12,000	24,000
17	23	11,500	23,000
18	22	11,000	22,000
19	21	10,500	21,000
20	20	10,000	20,000
21	19	9,500	19,000
22	18	9,000	18,000
23	17	8,500	17,000
24	17	8,500	17,000
25	16	8,000	16,000
26	16	8,000	16,000

PINS /Row	Q' ty/Tube	Q' ty/Inner Box	Q' ty/Box
27	15	7,500	15,000
28	15	7,500	15,000
29	14	7,000	14,000
30	14	7,000	14,000
31	13	6,500	13,000
32	13	6,500	13,000
33	12	6,000	12,000
34	12	6,000	12,000
35	12	6,000	12,000
36	11	5,500	11,000
37	11	5,500	11,000
38	11	5,500	11,000
39	11	5,500	11,000
40	10	5,000	10,000
41	10	5,000	10,000
42	10	5,000	10,000
43	9	4,500	9,000
44	9	4,500	9,000
45	9	4,500	9,000
46	9	4,500	9,000
47	9	4,500	9,000
48	9	4,500	9,000
49	8	4,000	8,000
50	8	4,000	8,000

PINS /Row	W	Q' ty/Reel	Q' ty/Inner Box	Q' ty/Box
2	16	2,400	9,600	28,800
3	16	2,400	9,600	28,800
4	24	2,400	7,200	21,600
5	24	2,400	7,200	21,600
6	24	2,400	7,200	21,600
7	24	2,400	7,200	21,600
8	24	2,400	7,200	21,600
9	24	2,400	7,200	21,600
10	24	2,000	6,000	18,000
11	32	2,400	4,800	14,400
12	32	2,400	4,800	14,400
13	32	2,400	4,800	14,400
14	32	2,400	4,800	14,400
15	44	2,400	4,800	14,400
16	44	2,400	4,800	14,400
17	44	2,400	4,800	14,400
18	44	2,400	4,800	14,400
19	44	2,400	4,800	14,400
20	44	2,400	4,800	14,400
21	44	2,400	4,800	14,400
22	44	2,400	4,800	14,400
23	44	2,400	4,800	14,400
24	56	2,400	2,400	7,200
25	56	2,400	2,400	7,200
26	56	2,400	2,400	7,200

PINS /Row	W	Q' ty/Reel	Q' ty/Inner Box	Q' ty/Box
27	56	2,400	2,400	7,200
28	56	2,400	2,400	7,200
29	56	2,400	2,400	7,200
30	56	2,400	2,400	7,200
31	56	2,400	2,400	7,200
32	56	2,400	2,400	7,200
33	72	2,400	2,400	7,200
34	72	2,400	2,400	7,200
35	72	2,400	2,400	7,200
36	72	2,400	2,400	7,200
37	72	2,400	2,400	7,200
38	72	2,400	2,400	7,200
39	72	2,400	2,400	7,200
40	72	2,400	2,400	7,200
41	72	2,400	2,400	7,200
42	72	2,400	2,400	7,200
43	72	2,400	2,400	7,200
44	72	2,400	2,400	7,200
45	72	2,400	2,400	7,200
46	88	2,400	2,400	7,200
47	88	2,400	2,400	7,200
48	88	2,400	2,400	7,200
49	88	2,400	2,400	7,200
50	88	2,400	2,400	7,200

A5	2025/12/15	Standardization Drawing	BAO	OPERATION	DRAW BAO	DATE	SCALE	FIT	PART NO.
A4	2023/02/03	Modify Flatness	XSR	x.X ±0.40	BAO	2025/12/15	UNIT	mm	2321-2XXMXXCUNX3
A3	2016/06/17	Modify CAP 3.00 → 3.40	-----	x.XX ±0.25	CHECK TANG	DATE	SIZE	A4	TITLE:
A0	2012/07/05	NEW	-----	x.XXX ±0.15	APPROVE Steven Zhao	2025/12/15	SHEET	3/3	1.27mm DUAL FEMALE HEADER SMT WITH OUTSIDE POST
REV	DATE	MODIFICATION DESCRIPTION	CHANGE	Angle ± 3'		DATE	PROJ.		Customer NO.
				DIM TOL		2025/12/15			



Http: [www.wcon.com](http://www.wcon.com)

WCON-Dongguan Tel: +86 769 85358920 Fax: +86 769 85358915 E-mail: <a href="mailto:sales@wcon.com">sales@wcon.com</a>	WCON-Kunshan Tel: +86 512 57468408 Fax: +86 512 57468468 E-mail: <a href="mailto:salesks@wcon.com">salesks@wcon.com</a>
---	--