

## WF2512 Series

2.50mm pitch/Wire-to-board Connector

## WF2512 系列

2.50mm间距/线到板连接器

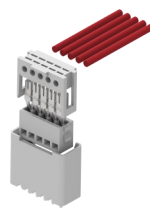
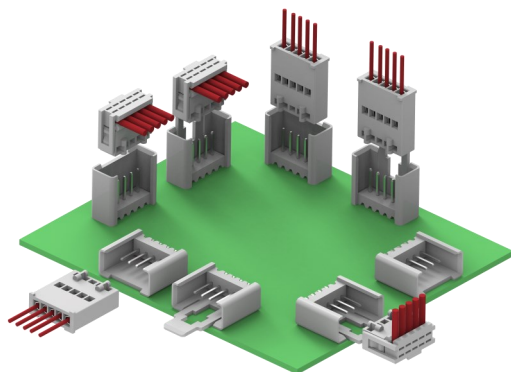

Pierce  
刺破

Two-point contact  
两点接触



Crimp  
压接

### Overview

WF2512 is a 2.50mm pitch wire-to-board connector. It offers two connection methods: piercing connection, which saves manpower and assembly costs, and crimp connection. It is equipped with a locking device to improve mating stability. The board end provides horizontal and vertical board mounting options to meet customers' different mating requirements.

### Features and Benefits

- Piercing connection saves manpower and manufacturing processes; crimp connection also available.
- Snap-in locking mechanism enhances mating stability.
- Double-wire solder tab design provides a more secure connection between the contact and the PCB board.
- Double-point contact ensures high contact reliability.

### Product Applications

- Industry: Automation equipment, testing equipment
- Consumer: Communication equipment, fitness equipment
- Home: Home appliance control

### Standard 标准

- EIA-364

### Material 材料

Part/零件	Material/材料	Finish/电镀	UL Flame retardant/阻燃等级
Housing/主体	PBT	Grey/灰色	UL94V-0
Rear cover/后盖	PBT	Grey/灰色	UL94V-0
Header/板端	PBT	Grey/灰色	UL94V-0
Terminal/端子	phosphor bronze 磷铜 (C5191)	Gold or Tin plated 镀金或镀锡	-

### 概述

WF2512是一款2.50mm间距线到板连接器，刺破式接线、压接式两种方式可供选择，带锁定装置提高互配稳定性，板端提供水平及垂直方向插板安装，可满足客户不同形态对插适配。

### 产品特点

- 刺破式接线节省人力、制程以及压接式可供选择
- 带卡入式锁定装置，增强互配稳定性
- 双线焊脚设计，接触件与PCB板连接更加牢固
- 双点接触，确保高接触可靠性

### 应用领域

- 工业:自动化设备、检测设备
- 消费:通讯设备、健身器材
- 家用:家电控制

Production Specifications 产品规格

Current rating 额定电流	5.0A	Operating Temperature Range:-40° C~+105° (including temperature rise) Operating Humidity Range:20-80% 工作温度范围: -40° C~+105° C(含温升) 工作湿度范围: ≤80%	Storage Teroerature: Operating Humidity: 储存温度: 25±5° C 储存湿度: ≤60%
Voltage rating 额定电压	320V		

Item 项目	Condition 条件	Specification 规格
Insulation Resistance 绝缘电阻	Measured at 1000V DC for 1 minute 测试电压: 1000V DC/1分钟	No less than 1000M Ω 不少于1000MΩ
Withstanding voltage 耐电压	Measured at 1500V AC for 1 minute 测试电压: 1500V AC/1分钟	No breakdown, no discharge, leakage current <0.5 mA 无击穿、无放电、漏电流<0.5 mA
Contact Resistance 接触电阻	Measured at 100mA and no higher than 20mV 用20 mV DC进行测量	Contact resistance: Initial value/ 20 mΩ max After environmental tests/ 30 mΩ max. 接触电阻: 初始值 20 mΩ 以下 测试后 30 mΩ 以下
Vibration Resistance 抗振动	Frequency : 50 ~ 2000 Hz PSD value : 5.35Gms minimum Duration : 15 minutes/axis Times : Each of three mutually perpendicular planes. 频率: 50 ~ 2000 Hz PSD 值: 5.35Gms minimum 时长: 15分钟/轴 次数: 三个相互垂直的平面中的每一个	No electrical discontinuity of 1μsorgreater 试验过程中未发生1μs瞬断现象, 且外观无损伤, 电气性能正常
Humidity (Steady state) 湿度	Temperature : 25~65°C Humidity: 90 ~95% (R.H) Duration : 96 hours 温度: 25~65° C 湿度: 90 ~95% (R.H) 时间: 96小时	Contact resistance: Initial value/ 20 mo max After environmental tests/ 30 mo max. 接触电阻: 初始值 20 mΩ 以下 测试后 30 mΩ 以下
Salt Spray 盐雾	Temperature:35±2°C Humidity:95~98%(R.H) PHValue : 6.5 ~ 7.2 Duration : 24 hours 温度: 35±2° C 湿度: 95~98%(R.H) PH值: 6.5~7.2 时间: 24H	Contact resistance: Initial value/ 20 mo max After environmental tests/ 30 mo max. 接触电阻: 初始值 20 mΩ 以下 测试后 30 mΩ 以下
Durability(Mating/un-mating) 插拔寿命	50 cycles 循环50次	Contact resistance: Initial value/ 20 mΩ max After environmental tests/ 30 mΩ max. 接触电阻: 初始值 20 mΩ 以下 测试后 30 mΩ 以下

## WF2512 Series

### Dimensions 尺寸 (R/A)

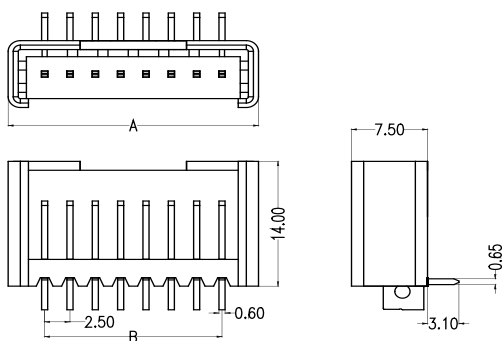

### Assembly Schematic 装配示意

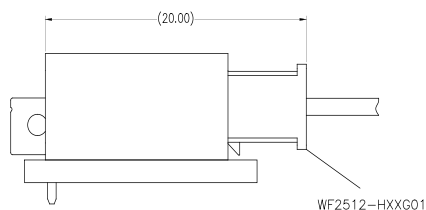

Through-hole type 通孔型  
R/A DIP

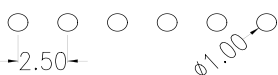

### Ordering Information 订购信

Circuit 芯数	Part number 型号	Dimensions 尺寸 (mm)		Package 包装 Q'ty/Tray 只/盒装	Remake 可量产状态
		A	B		
2	WF2512-WR02GA1	9.70	2.50	600	*
3	WF2512-WR03GA1	12.20	5.00	480	*
4	WF2512-WR04GA1	14.70	7.50	400	*
5	WF2512-WR05GA1	17.20	10.00	340	*
6	WF2512-WR06GA1	19.70	12.50	300	*
7	WF2512-WR07GA1	22.20	15.00	260	*
8	WF2512-WR08GA1	24.70	17.50	240	*
9	WF2512-WR09GA1	27.20	20.00	200	*
10	WF2512-WR10GA1	29.70	22.50	200	*
11	WF2512-WR11GA1	32.20	25.00	180	*
12	WF2512-WR12GA1	34.70	27.50	160	*
13	WF2512-WR13GA1	37.20	30.00	160	*
14	WF2512-WR14GA1	39.70	32.50	140	*
15	WF2512-WR15GA1	42.20	35.00	140	*
16	WF2512-WR16GA1	44.70	37.50	120	*
17	WF2512-WR17GA1	47.20	40.00	120	
18	WF2512-WR18GA1	49.70	42.50	120	
19	WF2512-WR19GA1	52.20	45.00	100	
20	WF2512-WR20GA1	54.70	47.50	100	

Note: \* stands for mass production . 注: \*代表可量产

### Dimensions 尺寸 (R/A)

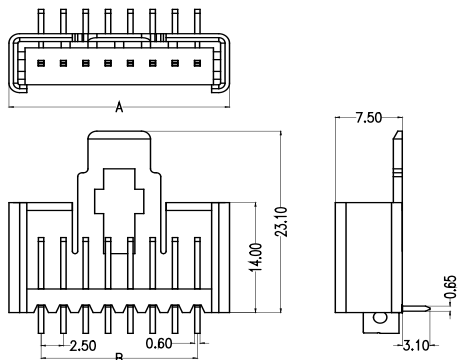

### Assembly Schematic 装配示意

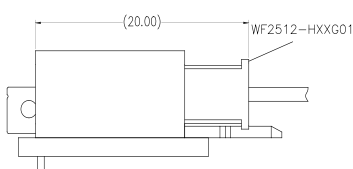

Through-hole type 通孔型  
R/A DIP



### Ordering Information 订购信

Circuit 芯数	Part number 型号	Dimensions 尺寸 (mm)		Package 包装 Q'ty/Tray 只/盒装	Remake 可量产状态
		A	B		
4	WF2512-WR04GA2	14.70	7.50	336	
5	WF2512-WR05GA2	17.20	10.00	288	
6	WF2512-WR06GA2	19.70	12.50	240	*
7	WF2512-WR07GA2	22.20	15.00	216	*
8	WF2512-WR08GA2	24.70	17.50	192	*
9	WF2512-WR09GA2	27.20	20.00	180	
10	WF2512-WR10GA2	29.70	22.50	156	
11	WF2512-WR11GA2	32.20	25.00	144	
12	WF2512-WR12GA2	34.70	27.50	132	
13	WF2512-WR13GA2	37.20	30.00	132	
14	WF2512-WR14GA2	39.70	32.50	120	
15	WF2512-WR15GA2	42.20	35.00	108	*
16	WF2512-WR16GA2	44.70	37.50	108	*
17	WF2512-WR17GA2	47.20	40.00	96	
18	WF2512-WR18GA2	49.70	42.50	96	
19	WF2512-WR19GA2	52.20	45.00	84	
20	WF2512-WR20GA2	54.70	47.50	84	

Note: \* stands for mass production . 注: \*代表可量产

Dimensions 尺寸 (R/A)

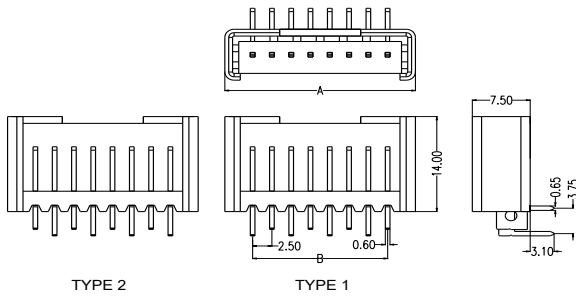

Assembly Schematic 装配示意

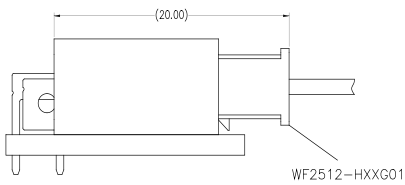

Through-hole type 通孔型  
R/A DIP

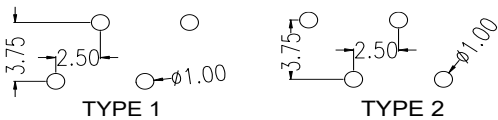

Ordering Information 订购信

Circuit 芯数	Part number 型号		Dimensions 尺寸		Package 包装 Qty/Bag 只/袋装	Remake 可量产 状态
	TYPE 1	TYPE 2	A	B		
2	WF2512-WR02GA3	WF2512-WR02GA5	9.70	2.50	600	*
3	WF2512-WR03GA3	WF2512-WR03GA5	12.20	5.00	480	*
4	WF2512-WR04GA3	WF2512-WR04GA5	14.70	7.50	400	*
5	WF2512-WR05GA3	WF2512-WR05GA5	17.20	10.00	340	*
6	WF2512-WR06GA3	WF2512-WR06GA5	19.70	12.50	300	*
7	WF2512-WR07GA3	WF2512-WR07GA5	22.20	15.00	260	*
8	WF2512-WR08GA3	WF2512-WR08GA5	24.70	17.50	240	*
9	WF2512-WR09GA3	WF2512-WR09GA5	27.20	20.00	200	*
10	WF2512-WR10GA3	WF2512-WR10GA5	29.70	22.50	200	*
11	WF2512-WR11GA3	WF2512-WR11GA5	32.20	25.00	180	*
12	WF2512-WR12GA3	WF2512-WR12GA5	34.70	27.50	160	*
13	WF2512-WR13GA3	WF2512-WR13GA5	37.20	30.00	160	*
14	WF2512-WR14GA3	WF2512-WR14GA5	39.70	32.50	140	*
15	WF2512-WR15GA3	WF2512-WR15GA5	42.20	35.00	140	*
16	WF2512-WR16GA3	WF2512-WR16GA5	44.70	37.50	120	*
17	WF2512-WR17GA3	WF2512-WR17GA5	47.20	40.00	120	*
18	WF2512-WR18GA3	WF2512-WR18GA5	49.70	42.50	120	*
19	WF2512-WR19GA3	WF2512-WR19GA5	52.20	45.00	100	*
20	WF2512-WR20GA3	WF2512-WR20GA5	54.70	47.50	100	*

Note: \* stands for mass production . 注: \*代表可量产

Dimensions 尺寸 (R/A)

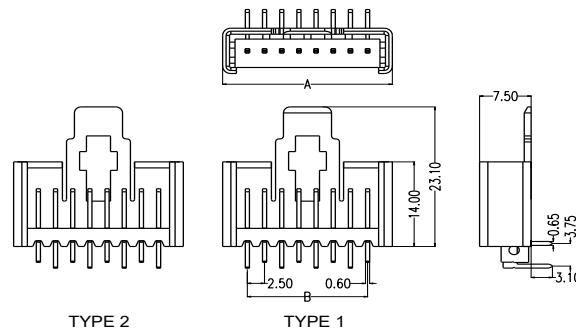

Assembly Schematic 装配示意

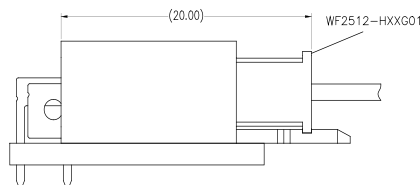

Through-hole type 通孔型  
R/A DIP

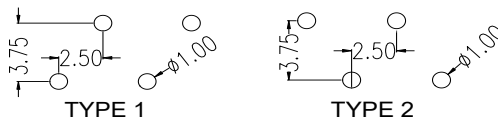

Ordering Information 订购信

Circuit 芯数	Part number 型号		Dimensions 尺寸		Package 包装 Qty/Bag 只/袋装	Remake 可量产 状态
	TYPE 1	TYPE 2	A	B		
4	WF2512-WR04GA4	WF2512-WR04GA6	14.70	7.50	336	
5	WF2512-WR05GA4	WF2512-WR05GA6	17.20	10.00	288	
6	WF2512-WR06GA4	WF2512-WR06GA6	19.70	12.50	240	*
7	WF2512-WR07GA4	WF2512-WR07GA6	22.20	15.00	216	*
8	WF2512-WR08GA4	WF2512-WR08GA6	24.70	17.50	192	*
9	WF2512-WR09GA4	WF2512-WR09GA6	27.20	20.00	180	
10	WF2512-WR10GA4	WF2512-WR10GA6	29.70	22.50	156	
11	WF2512-WR11GA4	WF2512-WR11GA6	32.20	25.00	144	
12	WF2512-WR12GA4	WF2512-WR12GA6	34.70	27.50	132	
13	WF2512-WR13GA4	WF2512-WR13GA6	37.20	30.00	132	
14	WF2512-WR14GA4	WF2512-WR14GA6	39.70	32.50	120	
15	WF2512-WR15GA4	WF2512-WR15GA6	42.20	35.00	108	*
16	WF2512-WR16GA4	WF2512-WR16GA6	44.70	37.50	108	*
17	WF2512-WR17GA4	WF2512-WR17GA6	47.20	40.00	96	
18	WF2512-WR18GA4	WF2512-WR18GA6	49.70	42.50	96	
19	WF2512-WR19GA4	WF2512-WR19GA6	52.20	45.00	84	
20	WF2512-WR20GA4	WF2512-WR20GA6	54.70	47.50	84	

Note: \* stands for mass production . 注: \*代表可量产

# WF2512 Series

## Dimensions 尺寸 (R/A)

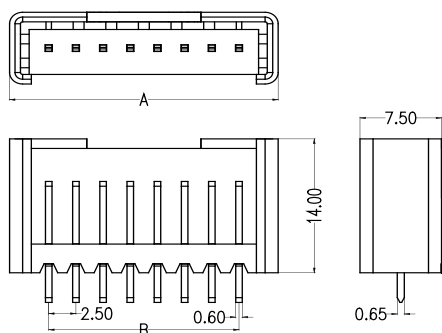

### Assembly Schematic 装配示意

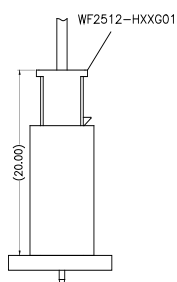

Through-hole type 通孔型  
S/T DIP



## Dimensions 尺寸 (S/T)

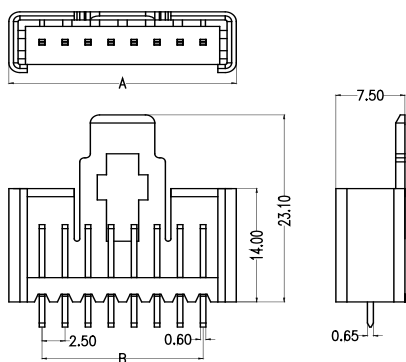

### Assembly Schematic 装配示意

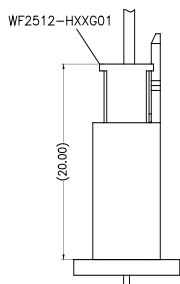

Through-hole type 通孔型  
S/T DIP



## Ordering Information 订购信

Circuit 芯数	Part number 型号	Dimensions 尺寸 (mm)		Package 包装 Q'ty/Tray 只/盒装	Remake 可量产状态
		A	B		
2	WF2512-WS02GA1	9.70	2.50	600	*
3	WF2512-WS03GA1	12.20	5.00	480	*
4	WF2512-WS04GA1	14.70	7.50	400	*
5	WF2512-WS05GA1	17.20	10.00	340	*
6	WF2512-WS06GA1	19.70	12.50	300	*
7	WF2512-WS07GA1	22.20	15.00	260	*
8	WF2512-WS08GA1	24.70	17.50	240	*
9	WF2512-WS09GA1	27.20	20.00	200	*
10	WF2512-WS10GA1	29.70	22.50	200	*
11	WF2512-WS11GA1	32.20	25.00	180	*
12	WF2512-WS12GA1	34.70	27.50	160	*
13	WF2512-WS13GA1	37.20	30.00	160	*
14	WF2512-WS14GA1	39.70	32.50	140	*
15	WF2512-WS15GA1	42.20	35.00	140	*
16	WF2512-WS16GA1	44.70	37.50	120	*
17	WF2512-WS17GA1	47.20	40.00	120	
18	WF2512-WS18GA1	49.70	42.50	120	
19	WF2512-WS19GA1	52.20	45.00	100	
20	WF2512-WS20GA1	54.70	47.50	100	

Note: \* stands for mass production . 注: \*代表可量产

## Ordering Information 订购信

Circuit 芯数	Part number 型号	Dimensions 尺寸 (mm)		Package 包装 Q'ty/Tray 只/盒装	Remake 可量产状态
		A	B		
4	WF2512-WS04GA2	14.70	7.50	336	
5	WF2512-WS05GA2	17.20	10.00	288	
6	WF2512-WS06GA2	19.70	12.50	240	*
7	WF2512-WS07GA2	22.20	15.00	216	*
8	WF2512-WS08GA2	24.70	17.50	192	*
9	WF2512-WS09GA2	27.20	20.00	180	
10	WF2512-WS10GA2	29.70	22.50	156	
11	WF2512-WS11GA2	32.20	25.00	144	
12	WF2512-WS12GA2	34.70	27.50	132	
13	WF2512-WS13GA2	37.20	30.00	132	
14	WF2512-WS14GA2	39.70	32.50	120	
15	WF2512-WS15GA2	42.20	35.00	108	*
16	WF2512-WS16GA2	44.70	37.50	108	*
17	WF2512-WS17GA2	47.20	40.00	96	
18	WF2512-WS18GA2	49.70	42.50	96	
19	WF2512-WS19GA2	52.20	45.00	84	
20	WF2512-WS20GA2	54.70	47.50	84	

Note: \* stands for mass production . 注: \*代表可量产

Dimensions 尺寸 (R/A)

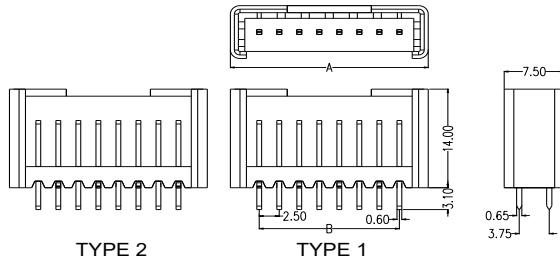

Assembly Schematic 装配示意

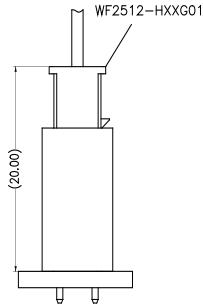

Through-hole type 通孔型  
S/T DIP

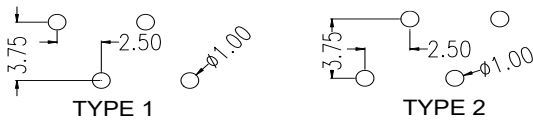

Ordering Information 订购信

Circuit 芯数	Part number 型号		Dimensions 尺寸		Package 包装 Q'ty/Tray 只/袋装	Remake 可量产 状态
	TYPE 1	TYPE 2	A	B		
2	WF2512-WS02GA3	WF2512-WS02GA5	9.70	2.50	600	*
3	WF2512-WS03GA3	WF2512-WS03GA5	12.20	5.00	480	*
4	WF2512-WS04GA3	WF2512-WS04GA5	14.70	7.50	400	*
5	WF2512-WS05GA3	WF2512-WS05GA5	17.20	10.00	340	*
6	WF2512-WS06GA3	WF2512-WS06GA5	19.70	12.50	300	*
7	WF2512-WS07GA3	WF2512-WS07GA5	22.20	15.00	260	*
8	WF2512-WS08GA3	WF2512-WS08GA5	24.70	17.50	240	*
9	WF2512-WS09GA3	WF2512-WS09GA5	27.20	20.00	200	*
10	WF2512-WS10GA3	WF2512-WS10GA5	29.70	22.50	200	*
11	WF2512-WS11GA3	WF2512-WS11GA5	32.20	25.00	180	*
12	WF2512-WS12GA3	WF2512-WS12GA5	34.70	27.50	160	*
13	WF2512-WS13GA3	WF2512-WS13GA5	37.20	30.00	160	*
14	WF2512-WS14GA3	WF2512-WS14GA5	39.70	32.50	140	*
15	WF2512-WS15GA3	WF2512-WS15GA5	42.20	35.00	140	*
16	WF2512-WS16GA3	WF2512-WS16GA5	44.70	37.50	120	*
17	WF2512-WS17GA3	WF2512-WS17GA5	47.20	40.00	120	
18	WF2512-WS18GA3	WF2512-WS18GA5	49.70	42.50	120	
19	WF2512-WS19GA3	WF2512-WS19GA5	52.20	45.00	100	
20	WF2512-WS20GA3	WF2512-WS20GA5	54.70	47.50	100	

Note: \* stands for mass production . 注: \*代表可量产

Dimensions 尺寸 (S/T)

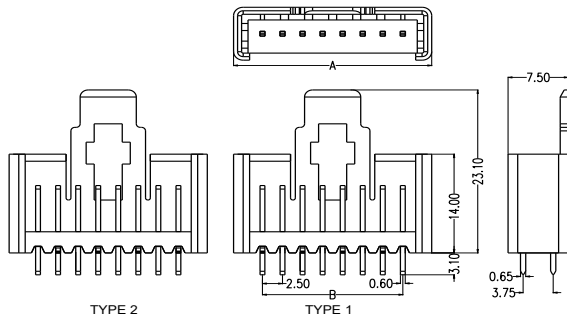

Assembly Schematic 装配示意

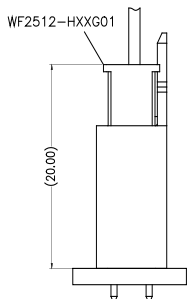

Through-hole type 通孔型  
S/T DIP

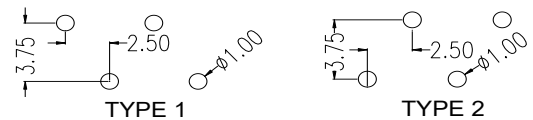

Ordering Information 订购信

Circuit 芯数	Part number 型号		Dimensions 尺寸		Package 包装 Q'ty/Tray 只/袋装	Remake 可量产 状态
	TYPE 1	TYPE 2	A	B		
2	WF2512-WS02GA4	WF2512-WS02GA6	9.70	2.50	504	
3	WF2512-WS03GA4	WF2512-WS03GA6	12.20	5.00	396	
4	WF2512-WS04GA4	WF2512-WS04GA6	14.70	7.50	336	
5	WF2512-WS05GA4	WF2512-WS05GA6	17.20	10.00	288	
6	WF2512-WS06GA4	WF2512-WS06GA6	19.70	12.50	240	*
7	WF2512-WS07GA4	WF2512-WS07GA6	22.20	15.00	216	*
8	WF2512-WS08GA4	WF2512-WS08GA6	24.70	17.50	192	*
9	WF2512-WS09GA4	WF2512-WS09GA6	27.20	20.00	180	
10	WF2512-WS10GA4	WF2512-WS10GA6	29.70	22.50	156	
11	WF2512-WS11GA4	WF2512-WS11GA6	32.20	25.00	144	
12	WF2512-WS12GA4	WF2512-WS12GA6	34.70	27.50	132	
13	WF2512-WS13GA4	WF2512-WS13GA6	37.20	30.00	132	
14	WF2512-WS14GA4	WF2512-WS14GA6	39.70	32.50	120	
15	WF2512-WS15GA4	WF2512-WS15GA6	42.20	35.00	108	*
16	WF2512-WS16GA4	WF2512-WS16GA6	44.70	37.50	108	*
17	WF2512-WS17GA4	WF2512-WS17GA6	47.20	40.00	96	
18	WF2512-WS18GA4	WF2512-WS18GA6	49.70	42.50	96	
19	WF2512-WS19GA4	WF2512-WS19GA6	52.20	45.00	84	
20	WF2512-WS20GA4	WF2512-WS20GA6	54.70	47.50	84	

Note: \* stands for mass production . 注: \*代表可量产

# WF2512 Series

## Ordering Information 订购信息

Circuit 芯数	Part number 型号		Dimensions 尺寸 (mm)		Parkage 包装 Qty/Bag 只/袋装	Remake 可量产状态	
			A	B		WF2512-HIXXGA2	WF2512X-HIXXXASNGXA1
2	WF2512-HI02GA2	WF2512X-HI02XASNGXA1	0	7.40	370	*	*
3	WF2512-HI03GA2	WF2512X-HI03XASNGXA1	2.50	9.90	280	*	*
4	WF2512-HI04GA2	WF2512X-HI04XASNGXA1	5.00	12.40	220	*	*
5	WF2512-HI05GA2	WF2512X-HI05XASNGXA1	7.50	14.90	180	*	*
6	WF2512-HI06GA2	WF2512X-HI06XASNGXA1	10.00	17.40	160	*	*
7	WF2512-HI07GA2	WF2512X-HI07XASNGXA1	12.50	19.90	140	*	*
8	WF2512-HI08GA2	WF2512X-HI08XASNGXA1	15.00	22.40	120	*	*
9	WF2512-HI09GA2	WF2512X-HI09XASNGXA1	17.50	24.90	110	*	*
10	WF2512-HI10GA2	WF2512X-HI10XASNGXA1	20.00	27.40	100	*	*
11	WF2512-HI11GA2	WF2512X-HI11XASNGXA1	22.50	29.90	90		
12	WF2512-HI12GA2	WF2512X-HI12XASNGXA1	25.00	32.40	80		
13	WF2512-HI13GA2	WF2512X-HI13XASNGXA1	27.50	34.90	80		
14	WF2512-HI14GA2	WF2512X-HI14XASNGXA1	30.00	37.40	70	*	*
15	WF2512-HI15GA2	WF2512X-HI15XASNGXA1	32.50	39.90	70	*	*
16	WF2512-HI16GA2	WF2512X-HI16XASNGXA1	35.00	42.40	60	*	*
17	WF2512-HI17GA2	WF2512X-HI17XASNGXA1	37.50	44.90	60		
18	WF2512-HI18GA2	WF2512X-HI18XASNGXA1	40.00	47.40	50		
19	WF2512-HI19GA2	WF2512X-HI19XASNGXA1	42.50	49.90	50		
20	WF2512-HI20GA2	WF2512X-HI20XASNGXA1	45.00	52.40	50		*

Note: \* stands for mass production . 注: \*代表可量产

### Dimensions 尺寸 (R/A)

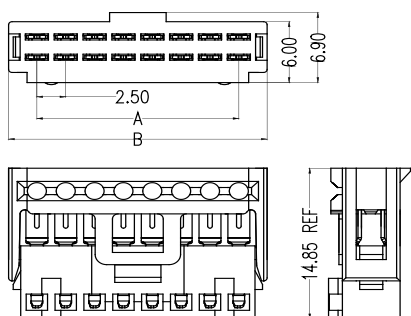

### Assembly Schematic 装配示意

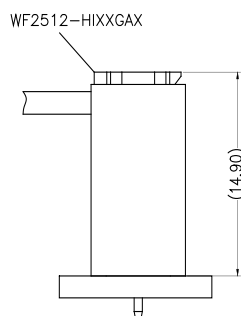

适配线号 Compatible cable numbers	24-26AWG
----------------------------------	----------

Dimensions 尺寸

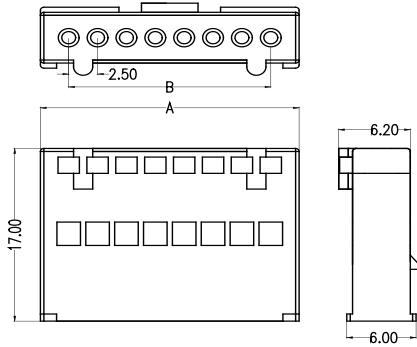

Adaptor Terminal 适配端子

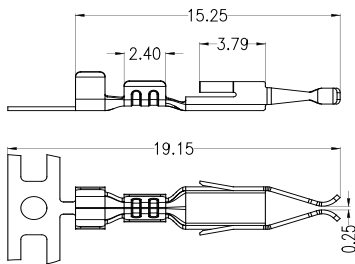

型号 Model number	WF2512-TPXX01
--------------------	---------------

Ordering Information 订购信息

Circuit 芯数	Part number 型号	Dimensions 尺寸 (mm)		Package 包装 Q'ty/Bag 只/袋装	Remake 可量产状态
		A	B		
2	WF2512-H02G01	7.40	2.50	1000	*
3	WF2512-H03G01	9.90	5.00	1000	*
4	WF2512-H04G01	12.40	7.50	1000	*
5	WF2512-H05G01	14.90	10.00	800	
6	WF2512-H06G01	17.40	12.50	800	
7	WF2512-H07G01	19.90	15.00	800	*
8	WF2512-H08G01	22.40	17.50	800	*
9	WF2512-H09G01	24.90	20.00	800	*
10	WF2512-H10G01	27.40	22.50	800	*
11	WF2512-H11G01	29.90	25.00	600	
12	WF2512-H12G01	32.40	27.50	600	
13	WF2512-H13G01	34.90	30.00	400	
14	WF2512-H14G01	37.40	32.50	400	
15	WF2512-H15G01	39.90	35.00	400	
16	WF2512-H16G01	42.40	37.50	400	
17	WF2512-H17G01	44.90	40.00	300	
18	WF2512-H18G01	47.40	42.50	300	
19	WF2512-H19G01	49.90	45.00	300	
20	WF2512-H20G01	52.40	47.50	300	

Note: \* stands for mass production . 注: \*代表可量产

Terminal Crimp specification 端子压接规范

型号 Model number	电线类型 Wire type	电线规格 Wire size	线缆 OD (mm) Cable OD (mm)	剥线长度 (mm) Strip length (mm)	导体铆压 (A-A) Conductor crimp			绝缘体铆压 (B-B) Insulation crimp	
					压接宽度CB1 Crimping width CB1±0.03mm	压接宽度CBm1 Crimping height CBm1+0.05mm	压接高度 Crimping height CH1±0.03mm	压接宽度CBm2 Crimping width CBm2±0.05mm	压接高度CH2 Crimping width CH2±0.08mm
WF2512-TPXX01	UL 1061	22AWG	0.85~1.50	1.80±0.25mm	1.20	1.23	0.76	1.60	1.35
	UL 1007	24AWG			1.19	1.22	0.76	1.55	1.20
	UL 1007	26AWG			1.20	1.23	0.64	1.55	1.20

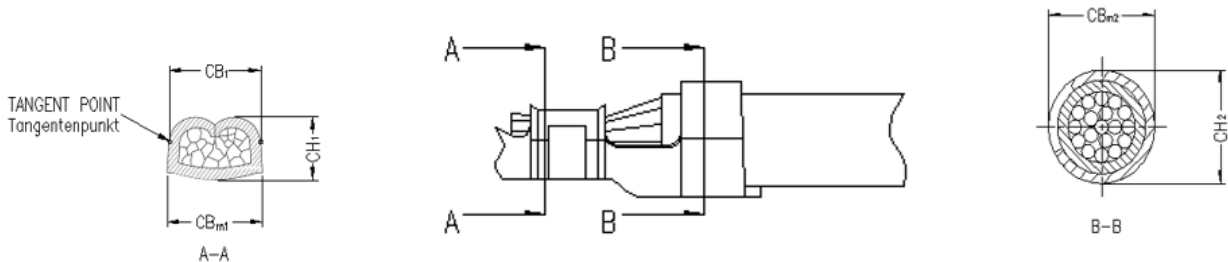

# WF2512 Series

## Model number allocation 型号命名

<b>WF2512</b>	-	<b>XX</b>	<b>XX</b>	<b>G</b>	<b>A</b>	<b>X</b>
(1)		(2)	(3)	(4)	(5)	(6)
(1) Series (系列): Wafer 2.50mm Series				(4) Color(颜色): G=Grey		
(2) Terminal type(端子形态): WS=S/T DIP WR=R/A DIP				(5) Packing(包装): A=Tray		
(3) Circuit(位数): 02=2P.....20=20P				(6) Internal code(流水码)		

<b>WF2512</b>	-	<b>H</b>	<b>XX</b>	<b>G</b>	<b>0</b>	<b>1</b>
(1)		(2)	(3)	(4)	(5)	(6)
(1) Series (系列): Wafer 2.50mm Series				(4) Color(颜色): G=Grey		
(2) Class shape code(类形状代码): H=Housing				(5) Packing(包装): 0=PE		
(3) Circuit(位数): 02=2P.....20=20P				(6) Internal code(流水码)		

<b>WF2512</b>	-	<b>HI</b>	<b>XX</b>	<b>G</b>	<b>A</b>	<b>X</b>
(1)		(2)	(3)	(4)	(5)	(6)
(1) Series (系列): Wafer 2.50mm Series				(4) Color(颜色): G=Grey		
(2) Class shape code(类形状代码): Pierce crimping				(5) Packing(包装): A=Tray		
(3) Circuit(位数): 02=2P.....20=20P				(6) Internal code(流水码)		

## Contact Us 联系我们

维峰电子股份有限公司(总部)  
WCON ELECTRONICS CO.,LTD(HQ)  
地址:广东省东莞市虎门镇大宁文明路15号  
Add :No.15,Wenming Road,Daning Community, Humen Town,  
Dongguan, Guangdong,523930, China

昆山维康电子有限公司  
KUNSHAN WCON ELECTRONICIS CO.,LTD(East of China)  
地址:江苏昆山市千灯镇汶浦中路169号  
Add : No.169, WenPu Middle Road, QianDeng Town, Kunshan  
City, Jiangsu Province, China

合肥维峰电子有限公司  
HEFEI WCON ELECTRONICIS CO.,LTD  
地址:安徽合肥市高新技术开发区绿城科技园E栋2楼  
Add : 2F, Building E, Greentown Science Park,High-tech Develop-  
ment Zone, Hefei, Anhui,China

维康电子(泰国)有限公司  
WCON ELECTRONICS (Thailand) CO.,LTD  
地址:泰国巴真武里府西玛铺县华瓦区洛加纳工业园  
Add: VG3C+H57, Hua Wa, Si Maha Phot District, Prachin Buri  
25140, Thailand

### 销售联系方式 Sales Contacts

国际客户部 International Sales Department  
salesdg01@wcon.com  
salesdg05@wcon.com

大客户专线 Key Account Line  
华南: salesdg28@wcon.com  
华东: salesks@wcon.com

中小客户专线 Small and Medium-sized Account Line  
华南: salesdg10@wcon.com  
华东: salesks01@wcon.com

网络销售 Online sales  
salesdg26@wcon.com



Official Website



Product e-catalog



WeChat Public#



TikTok Public#